



EMBROIDERY MACHINE

Single Head

Embroidery machine

WYE1501

Embroidery area: 360X220mm

Main features:

- Suitable for cap/tshirt/flat embroidery
- Auto BMP Pattern Recognition for Embroidery
- 10 inch touch screen computer supporting 16 languages
- 20,000,000 stitches memories matched with 200 patterns
- DST,DSB format are compatible
- Automatic thread break detection
- Automatic thread trimming
- 270°wide cap frame
- Automatic color change
- Emergency stop
- USB port and WIFI to transfer design available
- Various embroidery hoop sizes to meet customer's demands
- With foot wheels on machine body,easy for moving

Main Parameter:

Model	WYE1501
Head#	1
Needle#	15
Monitor	10"Lcd display
Operating Language	Chinese, English, French, Spanish, Portuguese, Turkish, German, Dutch, Thai, Arabic, Romania, Italian, Vietnamese, Hebrew, Polish, etc
Embroidery area	360*220mm
Speed	Max 1000SPM
Weight	45KG
Packing Size	1100*800*850mm
Voltage	100-250V
Power	150w



Accessories:

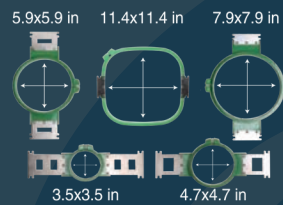

Single Head

Embroidery machine

WY1201C/WY1501C

Embroidery area: 510X360mm

Main features:

- Suitable for cap/tubular/tshirt/flat embroidery
- Auto BMP Pattern Recognition for Embroidery
- 10 inch touch screen computer supporting 16 languages
- 20,000,000 stitches memories matched with 200 patterns
- DST,DSB format are compatible
- Automatic thread break detection
- Automatic thread trimming
- 270°wide cap frame
- Automatic color change
- Emergency stop
- USB port and WIFI to transfer design available
- Various embroidery hoop sizes to meet customer's demands
- With foot wheels on machine body,easy for moving

Main Parameter:

Model	WY1201C/WY1501C
Head#	1
Needle#	12/15
Monitor	10"Led display
Operating Language	Chinese, English, French, Spanish, Portuguese, Turkish, German, Dutch, Thai, Arabic, Romania, Italian, Vietnamese, Hebrew, Polish, etc
Embroidery area	510*360mm
Speed	Max 1200SPM
Weight	168KG
Packing Size	1100*800*850mm
Voltage	100-250V
Power	150w



Accessories:

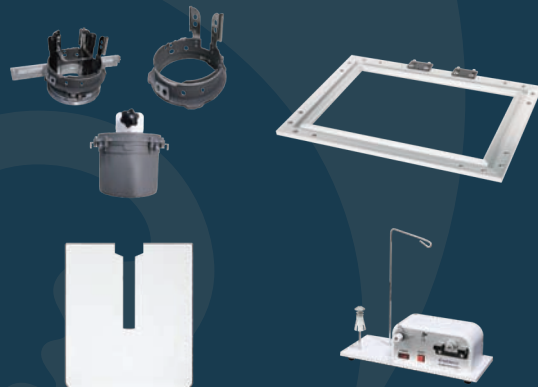
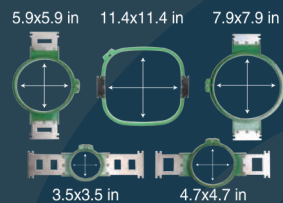

Single Head

Embroidery machine

WY1201CM/WY1501CM

Embroidery area: 800X500mm

Main features:

- Suitable for cap/tubular/tshirt/flat embroidery
- Auto BMP Pattern Recognition for Embroidery
- 10 inch touch screen computer supporting 16 languages
- 20,000,000 stitches memories matched with 200 patterns
- DST,DSB format are compatible
- Automatic thread break detection
- Automatic thread trimming
- 270°wide cap frame
- Automatic color change
- Emergency stop
- USB port and WIFI to transfer design available
- Various embroidery hoop sizes to meet customer's demands
- With foot wheels on machine body,easy for moving

Main Parameter:

Model	WY1201CM/WY1501CM
Head#	1
Needle#	12/15
Monitor	10"Led display
Operating Language	Chinese, English, French, Spanish, Portuguese, Turkish, German, Dutch, Thai, Arabic, Romania, Italian, Vietnamese, Hebrew, Polish, etc
Embroidery area	800*500mm
Speed	Max 1200SPM
Weight	255KG
Packing Size	1230*1230*1090mm
Voltage	100-250V
Power	150w



Accessories:

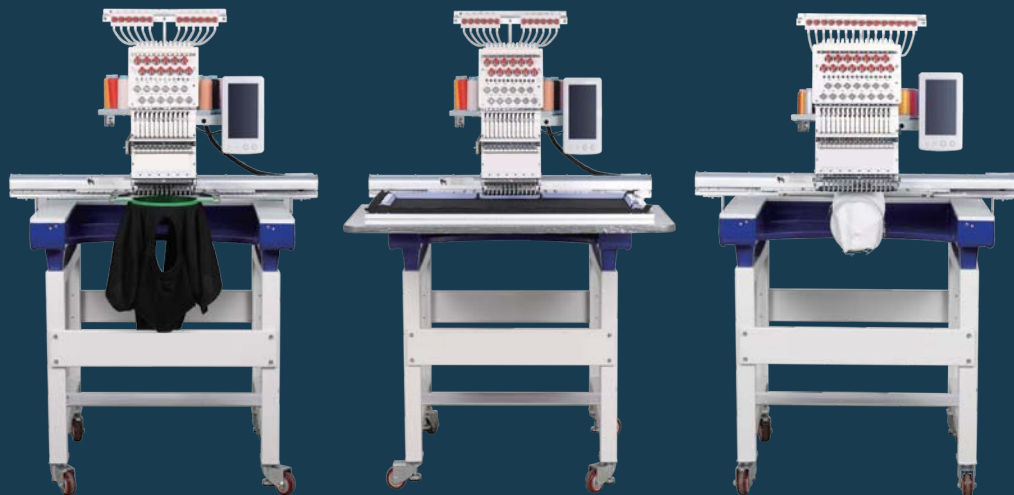
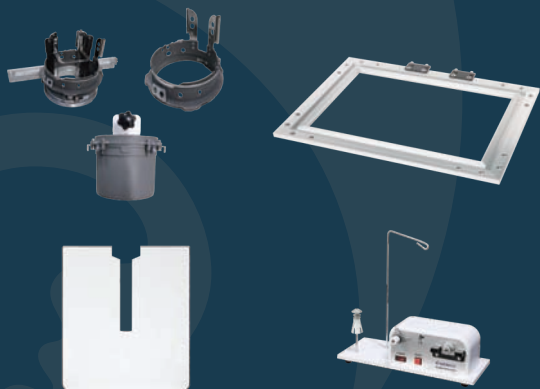
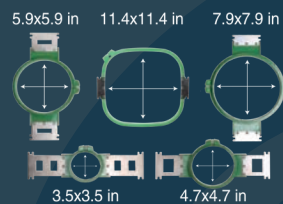

Single Head

Embroidery machine

WY1201CL/WY1501CL

WY1201CML/WY1501CML

Embroidery area: 1200X360mm/1200X500mm

Main features:

- Suitable for cap/tubular/tshirt/flat embroidery
- Auto BMP Pattern Recognition for Embroidery
- 10 inch touch screen computer supporting 16 languages
- 20,000,000 stitches memories matched with 200 patterns
- DST,DSB format are compatible
- Automatic thread break detection
- Automatic thread trimming
- 270°wide cap frame
- Automatic color change
- Emergency stop
- USB port and WIFI to transfer design available
- Various embroidery hoop sizes to meet customer's demands
- With foot wheels on machine body,easy for moving

Main Parameter:

Model	WY1201CL/WY1501CL WY1201CML/WY1501CML
Head#	1
Needle#	12/15
Monitor	10"Led display
Operating Language	Chinese, English, French, Spanish, Portuguese, Turkish, German, Dutch, Thai, Arabic, Romania, Italian, Vietnamese, Hebrew, Polish, etc
Embroidery area	1200*360mm/1200*500mm
Speed	Max 1200SPM
Weight	210KG/285KG
Packing Size	1530*950*1040mm/1530*1230*1090mm
Voltage	100-250V
Power	150w



Accessories:



Single Head

Embroidery machine

WYQ901/WYQ1201/WYQ1501

Embroidery area: 360X200mm

Main features:

- Suitable for cap/tubular/tshirt/flat embroidery
- Auto BMP Pattern Recognition for Embroidery
- 10 inch touch screen computer supporting 16 languages
- 20,000,000 stitches memories matched with 200 patterns
- DST,DSB format are compatible
- Automatic thread break detection
- Automatic thread trimming
- 270°wide cap frame
- Automatic color change
- Emergency stop
- USB port and WIFI to transfer design available
- Various embroidery hoop sizes to meet customer's demands
- With foot wheels on machine body,easy for moving

Main Parameter:

Model	WYQ901/WYQ1201/WYQ1501
Head#	1
Needle#	9/12/15
Monitor	10"Lcd display
Operating Language	Chinese, English, French, Spanish, Portuguese, Turkish, German, Dutch, Thai, Arabic, Romania, Italian, Vietnamese, Hebrew, Polish, etc
Embroidery area	360*200mm
Speed	Max 1200SPM
Weight	158KG
Packing Size	1100*800*850mm
Voltage	100-250V
Power	150w



Accessories:

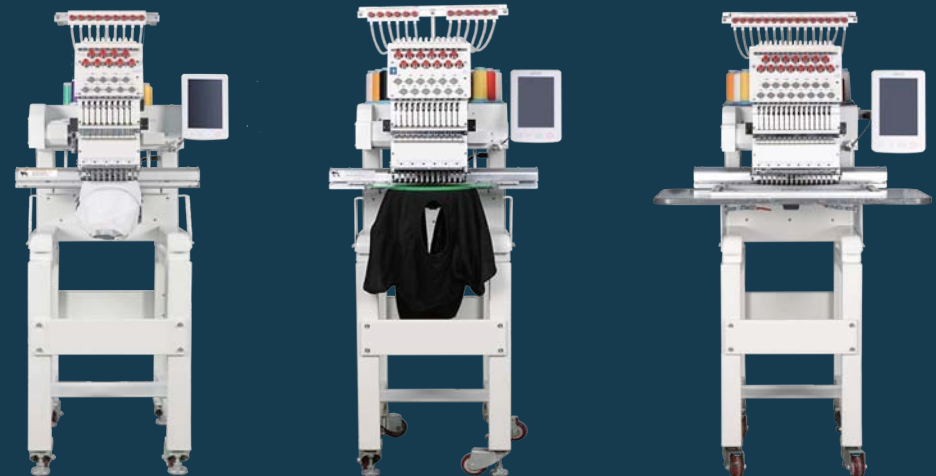
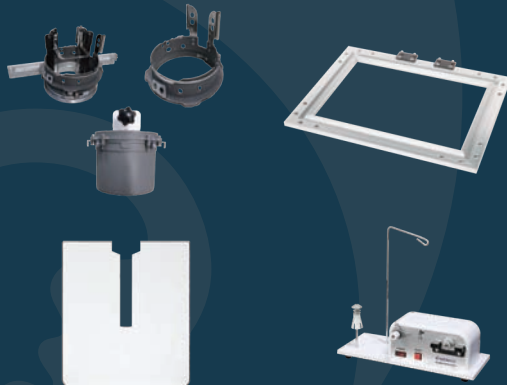
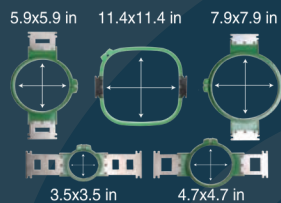

Single Head

Embroidery machine

WYQ901L / WYQ1201L / WYQ1501L

Embroidery area: 600X400mm

Main features:

- Suitable for cap/tubular/tshirt/flat embroidery
- Auto BMP Pattern Recognition for Embroidery
- 10 inch touch screen computer supporting 16 languages
- 20,000,000 stitches memories matched with 200 patterns
- DST,DSB format are compatible
- Automatic thread break detection
- Automatic thread trimming
- 270°wide cap frame
- Automatic color change
- Emergency stop
- USB port and WIFI to transfer design available
- Various embroidery hoop sizes to meet customer's demands
- With foot wheels on machine body,easy for moving

Main Parameter:

Model	WYQ901L/WYQ1201L/WYQ1501L
Head#	1
Needle#	9/12/15
Monitor	10"Led display
Operating Language	Chinese, English, French, Spanish, Portuguese, Turkish, German, Dutch, Thai, Arabic, Romania, Italian, Vietnamese, Hebrew, Polish, etc
Embroidery area	600*400mm
Speed	Max 1200SPM
Weight	226KG
Packing Size	1230*1030*1150mm
Voltage	100-250V
Power	150w



Accessories:

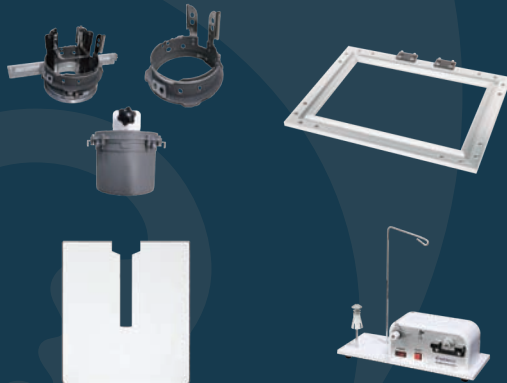
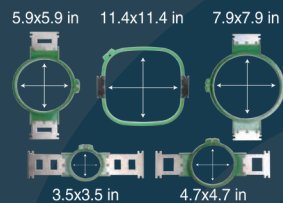

Single Head

Embroidery machine

WYQ901ML/WYQ1201ML/WYQ1501ML

Embroidery area: 1300X600mm

Main features:

- Suitable for cap/tubular/tshirt/flat embroidery
- Auto BMP Pattern Recognition for Embroidery
- 10 inch touch screen computer supporting 16 languages
- 20,000,000 stitches memories matched with 200 patterns
- DST,DSB format are compatible
- Automatic thread break detection
- Automatic thread trimming
- 270°wide cap frame
- Automatic color change
- Emergency stop
- USB port and WIFI to transfer design available
- Various embroidery hoop sizes to meet customer's demands
- With foot wheels on machine body,easy for moving

Main Parameter:

Model	WYQ901ML/WYQ1201ML/WYQ1501ML
Head#	1
Needle#	9/12/15
Monitor	10"Led display
Operating Language	Chinese, English, French, Spanish, Portuguese, Turkish, German, Dutch, Thai, Arabic, Romania, Italian, Vietnamese, Hebrew, Polish, etc
Embroidery area	1300*600mm
Speed	Max 1200SPM
Weight	290KG
Packing Size	1730*1300*1090mm
Voltage	100-250V
Power	150w



Accessories:

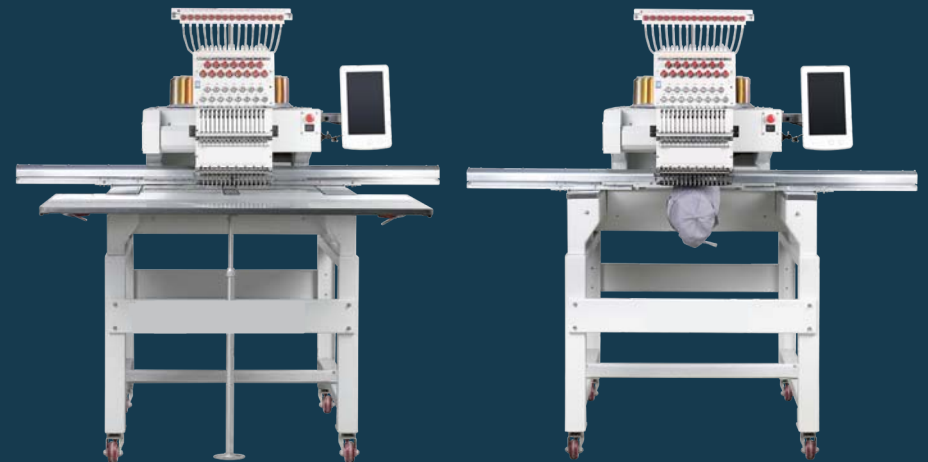
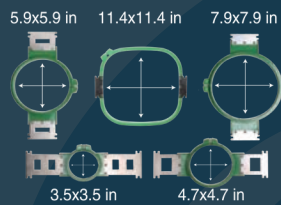

2 Head

Embroidery machine

WYQ902/WYQ1202/WYQ1502

Embroidery area: 500X450mm

Main features:

- Suitable for cap/tubular/tshirt/flat embroidery
- Auto BMP Pattern Recognition for Embroidery
- 10 inch touch screen computer supporting 16 languages
- 20,000,000 stitches memories matched with 200 patterns
- DST,DSB format are compatible
- Automatic thread break detection
- Automatic thread trimming
- 270°wide cap frame
- Automatic color change
- Emergency stop
- USB port and WIFI to transfer design available
- Various embroidery hoop sizes to meet customer's demands
- With foot wheels on machine body,easy for moving

Main Parameter:

Model	WYQ902/WYQ1202/WYQ1502
Head#	2
Needle#	9/12/15
Monitor	10"Led display
Operating Language	Chinese, English, French, Spanish, Portuguese, Turkish, German, Dutch, Thai, Arabic, Romania, Italian, Vietnamese, Hebrew, Polish, etc
Embroidery area	500*450mm
Speed	Max 1000SPM
Weight	410KG
Packing Size	1430*1030*1050mm
Voltage	100-250V
Power	450w



Accessories:

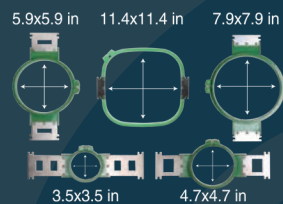

3 Head

Embroidery machine

WYQ903/WYQ1203/WYQ1503

Embroidery area: 500X450mm

Main features:

- Suitable for cap/tubular/tshirt/flat embroidery
- Auto BMP Pattern Recognition for Embroidery
- 10 inch touch screen computer supporting 16 languages
- 20,000,000 stitches memories matched with 200 patterns
- DST,DSB format are compatible
- Automatic thread break detection
- Automatic thread trimming
- 270°wide cap frame
- Automatic color change
- Emergency stop
- USB port and WIFI to transfer design available
- Various embroidery hoop sizes to meet customer's demands
- With foot wheels on machine body,easy for moving

Main Parameter:

Model	WYQ903/WYQ1203/WYQ1503
Head#	3
Needle#	9/12/15
Monitor	10"Led display
Operating Language	Chinese, English, French, Spanish, Portuguese, Turkish, German, Dutch, Thai, Arabic, Romania, Italian, Vietnamese, Hebrew, Polish, etc
Embroidery area	500*450mm
Speed	Max 1000SPM
Weight	555KG
Packing Size	1950*1050*1740mm
Voltage	100-250V
Power	450w



Accessories:

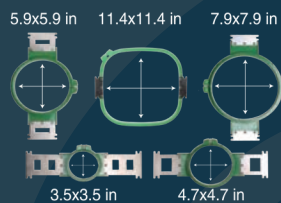

4 Head

Embroidery machine

WYQ904/WYQ1204/WYQ1504

Embroidery area: 500X450mm

Main features:

- Suitable for cap/tubular/tshirt/flat embroidery
- Auto BMP Pattern Recognition for Embroidery
- 10 inch touch screen computer supporting 16 languages
- 20,000,000 stitches memories matched with 200 patterns
- DST,DSB format are compatible
- Automatic thread break detection
- Automatic thread trimming
- 270°wide cap frame
- Automatic color change
- Emergency stop
- USB port and WIFI to transfer design available
- Various embroidery hoop sizes to meet customer's demands
- With foot wheels on machine body,easy for moving

Main Parameter:

Model	WYQ904/WYQ1204/WYQ1504
Head#	4
Needle#	9/12/15
Monitor	10"Led display
Operating Language	Chinese, English, French, Spanish, Portuguese, Turkish, German, Dutch, Thai, Arabic, Romania, Italian, Vietnamese, Hebrew, Polish, etc
Embroidery area	500*450mm
Speed	Max 1000SPM
Weight	850KG
Packing Size	2450*1050*1740mm
Voltage	100-250V
Power	750w



Accessories:

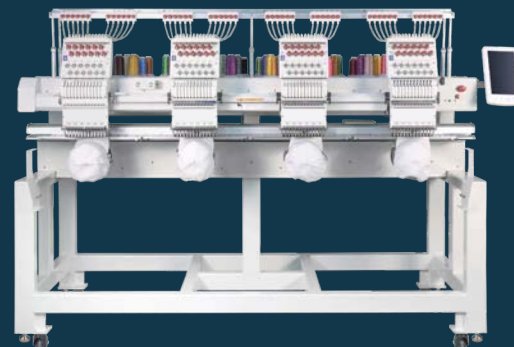
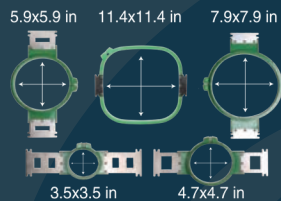

6 Head

Embroidery machine

WYQ906/WYQ1206/WYQ1506

Embroidery area: 500X450mm

Main features:

- Suitable for cap/tubular/tshirt/flat embroidery/ Direct photo embroidery
- Auto BMP Pattern Recognition for Embroidery
- 10 inch touch screen computer supporting 16 languages
- 20,000,000 stitches memories matched with 200 patterns
- DST,DSB format are compatible
- Automatic thread break detection
- Automatic thread trimming
- 270°wide cap frame
- Automatic color change
- Emergency stop
- USB port and WIFI to transfer design available
- Various embroidery hoop sizes to meet customer's demands
- With foot wheels on machine body,easy for moving

Main Parameter:

Model	WYQ906/WYQ1206/WYQ1506
Head#	6
Needle#	9/12/15
Monitor	10"Led display
Operating Language	Chinese, English, French, Spanish, Portuguese, Turkish, German, Dutch, Thai, Arabic, Romania, Italian, Vietnamese, Hebrew, Polish, etc
Embroidery area	500*450mm
Speed	Max 1000SPM
Weight	1165KG
Packing Size	2930*1080*1740mm
Voltage	100-250V
Power	1000w



Accessories:

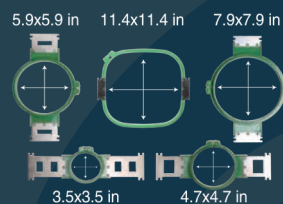

8 Head

Embroidery machine

WYQ908 / WYQ1208 / WYQ1508

Embroidery area: 400X450mm

Main features:

- Suitable for cap/tubular/tshirt/flat embroidery/ Direct photo embroidery
- Auto BMP Pattern Recognition for Embroidery
- 10 inch touch screen computer supporting 16 languages
- 20,000,000 stitches memories matched with 200 patterns
- DST,DSB format are compatible
- Automatic thread break detection
- Automatic thread trimming
- 270°wide cap frame
- Automatic color change
- Emergency stop
- USB port and WIFI to transfer design available
- Various embroidery hoop sizes to meet customer's demands
- With foot wheels on machine body,easy for moving

Main Parameter:

Model	WYQ908/WYQ1208/WYQ1508
Head#	8
Needle#	9/12/15
Monitor	10"Lcd display
Operating Language	Chinese, English, French, Spanish, Portuguese, Turkish, German, Dutch, Thai, Arabic, Romania, Italian, Vietnamese, Hebrew, Polish, etc
Embroidery area	400*450mm
Speed	Max 1000SPM
Weight	1400KG
Packing Size	3700*1100*1740mm
Voltage	100-250V
Power	1500w



Accessories:

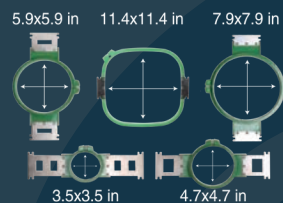

10 Head

Embroidery machine

WY910CH/WY1210CH/WY1510CH

Embroidery area: 400X450mm

Main features:

- Suitable for cap/tubular/tshirt/flat embroidery/ Direct photo embroidery
- Auto BMP Pattern Recognition for Embroidery
- 10 inch touch screen computer supporting 16 languages
- 20,000,000 stitches memories matched with 200 patterns
- DST,DSB format are compatible
- Automatic thread break detection
- Automatic thread trimming
- 270°wide cap frame
- Automatic color change
- Emergency stop
- USB port and WIFI to transfer design available
- Various embroidery hoop sizes to meet customer's demands
- With foot wheels on machine body,easy for moving

Main Parameter:

Model	WY910CH/WY1210CH/WY1510CH
Head#	10
Needle#	9/12/15
Monitor	10"Led display
Operating Language	Chinese, English, French, Spanish, Portuguese, Turkish, German, Dutch, Thai, Arabic, Romania, Italian, Vietnamese, Hebrew, Polish, etc
Embroidery area	400*450mm
Speed	Max 1000SPM
Weight	1500KG
Packing Size	5300*1050*1740mm
Voltage	100-250V
Power	1500w



Accessories:

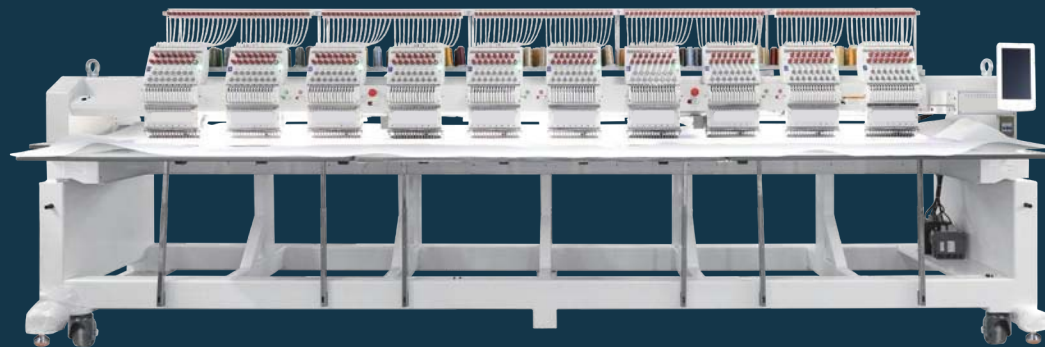

12 Head

Embroidery machine

WY912CH/WY1212CH/WY1512CH

Embroidery area: 400X450mm



Main features:

- Suitable for cap/tubular/tshirt/flat embroidery/ Direct photo embroidery
- Auto BMP Pattern Recognition for Embroidery
- 10 inch touch screen computer supporting 16 languages
- 20,000,000 stitches memories matched with 200 patterns
- DST,DSB format are compatible
- Automatic thread break detection
- Automatic thread trimming
- 270°wide cap frame
- Automatic color change
- Emergency stop
- USB port and WIFI to transfer design available
- Various embroidery hoop sizes to meet customer's demands
- With foot wheels on machine body,easy for moving

Main Parameter:

Model	WY912CH/WY1212CH/WY1512CH
Head#	12
Needle#	9/12/15
Monitor	10"Led display
Operating Language	Chinese, English, French, Spanish, Portuguese, Turkish, German, Dutch, Thai, Arabic, Romania, Italian, Vietnamese, Hebrew, Polish, etc
Embroidery area	400*450mm
Speed	Max 1000SPM
Weight	1957KG
Packing Size	6100*1050*1740mm
Voltage	100-250V
Power	1500w

Accessories:



Mix Chenille Chain Stitch

Embroidery machine

Embroidery area: 1200X500mm



10-inch operation screen



Process diversity

Main features:

- Suitable for tshirt/flat embroidery
- Auto BMP Pattern Recognition for Embroidery
- 10 inch touch screen computer supporting 16 languages
- 20,000,000 stitches memories matched with 200 patterns
- DST,DSB format are compatible
- Automatic thread break detection
- Automatic thread trimming
- Automatic color change
- Emergency stop
- USB port and WIFI to transfer design available
- Various embroidery hoop sizes to meet customer's demands
- With foot wheels on machine body,easy for moving

Main Parameter:

Model	WY1201+1M/WY1501+1M
Head#	1+1\2+2\4+4\6+6\8+8
Needle#	12/15
Monitor	10"LCD display
Operating Language	Chinese, English, French, Spanish, Portuguese, Turkish, German, Dutch, Thai, Arabic, Romania, Italian, Vietnamese, Hebrew, Polish, etc
Embroidery area	1200*500mm
Speed	Max 650SPM
Weight	850KG
Packing Size	2350*1150*1740mm
Voltage	100-250V
Power	1500w

Sample:

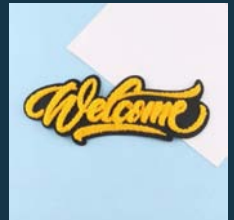

Taping

Embroidery machine

Embroidery area: 1200X500mm

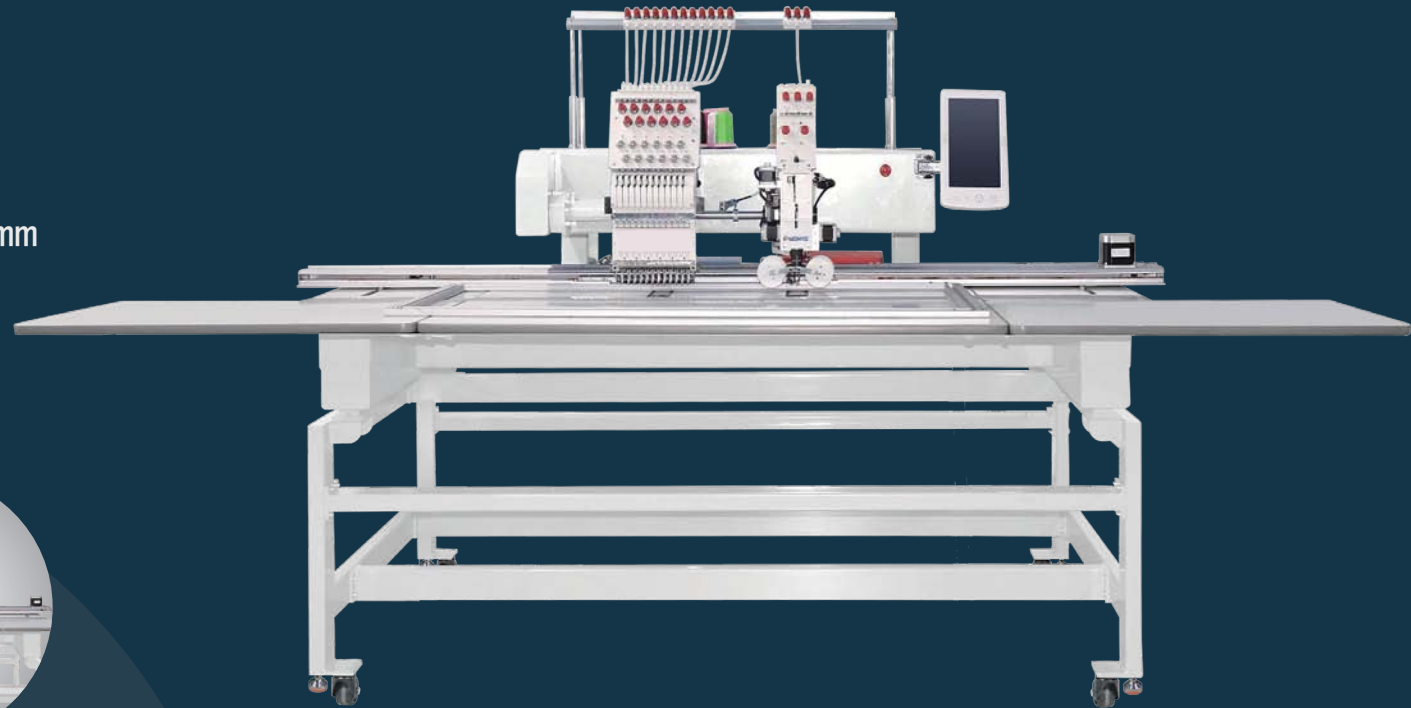

Embroidery effect is rich



High production efficiency

Main features:

- Suitable for tape/tshirt/flat embroidery
- Auto BMP Pattern Recognition for Embroidery
- 10 inch touch screen computer supporting 16 languages
- 20,000,000 stitches memories matched with 200 patterns
- DST,DSB format are compatible
- Automatic thread break detection
- Automatic thread trimming
- Automatic color change
- Emergency stop
- USB port and WIFI to transfer design available
- Various embroidery hoop sizes to meet customer's demands
- With foot wheels on machine body,easy for moving

Main Parameter:

Model	WY1201+1P/WY1501+1P
Head#	1+1\2+2\4+4\6+6\8+8
Needle#	12/15
Monitor	10" Lcd display
Operating Language	Chinese, English, French, Spanish, Portuguese, Turkish, German, Dutch, Thai, Arabic, Romania, Italian, Vietnamese, Hebrew, Polish, etc
Embroidery area	1200*500mm
Speed	Max 1000SPM
Weight	800KG
Packing Size	2350*1150*1740mm
Voltage	100-250V
Power	1200w

Sample:

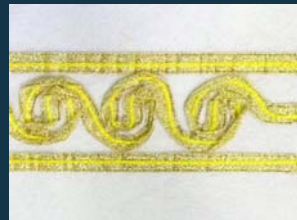

Professional Design Software iSEW EMCAD

- Provide beginners and professionals with more affordable and powerful tools
- Customized for professional stores and retail end users
- Post-import Auto-Processing for Embroidery Machine Format
- Universal for use on multi-brand machines, automatically input in multiple languages and fonts to generate embroidery files
- Humanized user interface
- Customizable working interface
- Multiple pattern view options

Alphabet embroidery Edit letter pattern:

The program provides a variety of built-in fonts to facilitate the editing of letter patterns. Handling of letter pattern fill stitches and letter outline running stitches. And provide a variety of alphabetical arrangements.

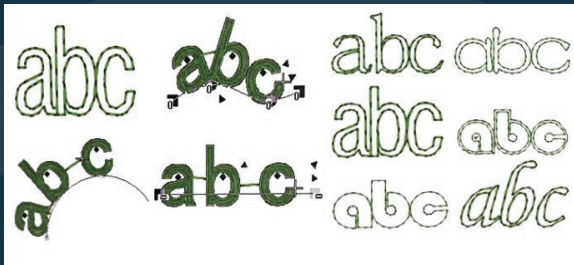

Photo embroidery:

The program can automatically recognize and pattern Jpeg and Jpg format image files, directly transfer high-definition photos of people, etc. The machine and the operating head can automatically digitally pattern and embroider.



Jagged edge effect:

The program provides multiple processing methods for jagged edges.

- Single-sided sawtooth and double-sided sawtooth in the common way
- Single-sided jagged edges and double-sided jagged edges processed according to the scaling coefficient and scaling quantity
- Special Effects

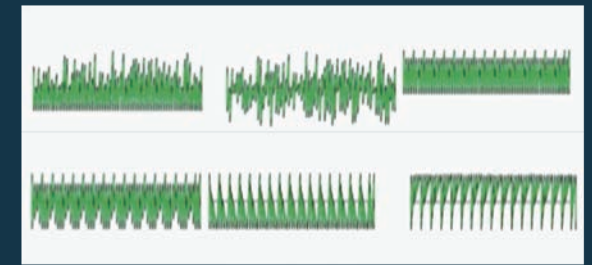

Custom segmentation effect:

Use one or more custom curves as dividing lines, and use these dividing lines to divide the already completed patterns, making the effect of leaves or petals more natural.

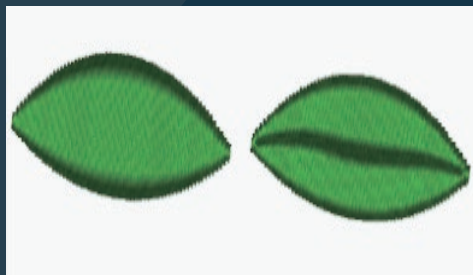

Support multiple stitch patterns:

Supports various contour stitches, single stitches, theme single stitches, rope-like stitches, round-trip stitches, etc.



Copy effect:

The program can copy a series of objects in a garland, matrix and linear manner.

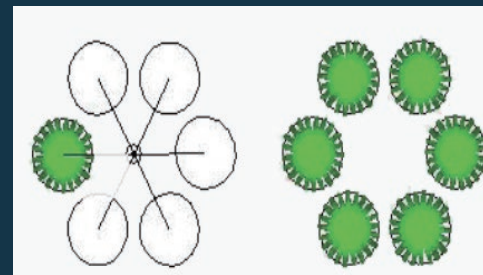

Intelligent corner effect:

The processing result of the corner can be adjusted by customizing the corner attribute. Currently, two corner effects are supported, including beveled seam corners and cap-shaped corners.

