

## Specification

Model	Needle	Needle No.	Thread No.	Stitch Width (mm)	Stitch Length (mm)	Differential Ratio	Presser Foot Lifting Height (mm)	Max. Speed (s.p.m)	Volume (mm)	Weight (kg)
K5-UT2-01GB	UY128GAS 11-14#	3	5	1.5-4.5	5.6/6.4	0.8-1.3	7	5500	670×445×595	52/62
K5-UT2-02GB	UY128GAS 11-14#	3	5	1.5-4.5	5.6/6.4	0.8-1.3	7	5500	670×445×595	52/62
K5-UT2-03GB	UY128GAS 11-14#	3	5	1.5-4.5	5.6/6.4	0.8-1.3	7	5500	670×445×595	52/62
K5-UT2-08AC	UY128GAS 11-14#	3	5	1.5-4.5	5.6/6.4	0.8-1.3	7	5500	670×445×595	52/62
K5-UT2-35AC	UY128GAS 11-14#	3	5	1.5-4.5	5.6/6.4	0.8-1.3	7	5000	670×445×720	53/65
K5-D-01GB	UY128GAS 11-14#	3	5	1.5-4.5	5.6/6.4	0.8-1.3	7	5500	670×445×595	46/56
K5-D-02BB	UY128GAS 11-14#	3	5	1.5-4.5	5.6/6.4	0.8-1.3	7	5500	670×445×595	46/56
K5-D-03GB	UY128GAS 11-14#	3	5	1.5-4.5	5.6/6.4	0.8-1.3	7	5500	670×445×595	46/56
K5-D-08AC	UY128GAS 11-14#	3	5	1.5-4.5	5.6/6.4	0.8-1.3	7	5500	670×445×595	46/56
K5-D-35AC	UY128GAS 11-14#	3	5	1.5-4.5	5.6/6.4	0.8-1.3	7	5000	670×445×720	47/59

**Note:**

1.UT2: computerized machine, standard: with thread wiper, without upper thread trimmer D: direct drive  
 2.UT type computerized machine is optional, standard: with thread wiper and upper thread trimmer; UTL pneumatic type computerized is optional (pneumatic thread trimming+ pneumatic foot lifter presser)

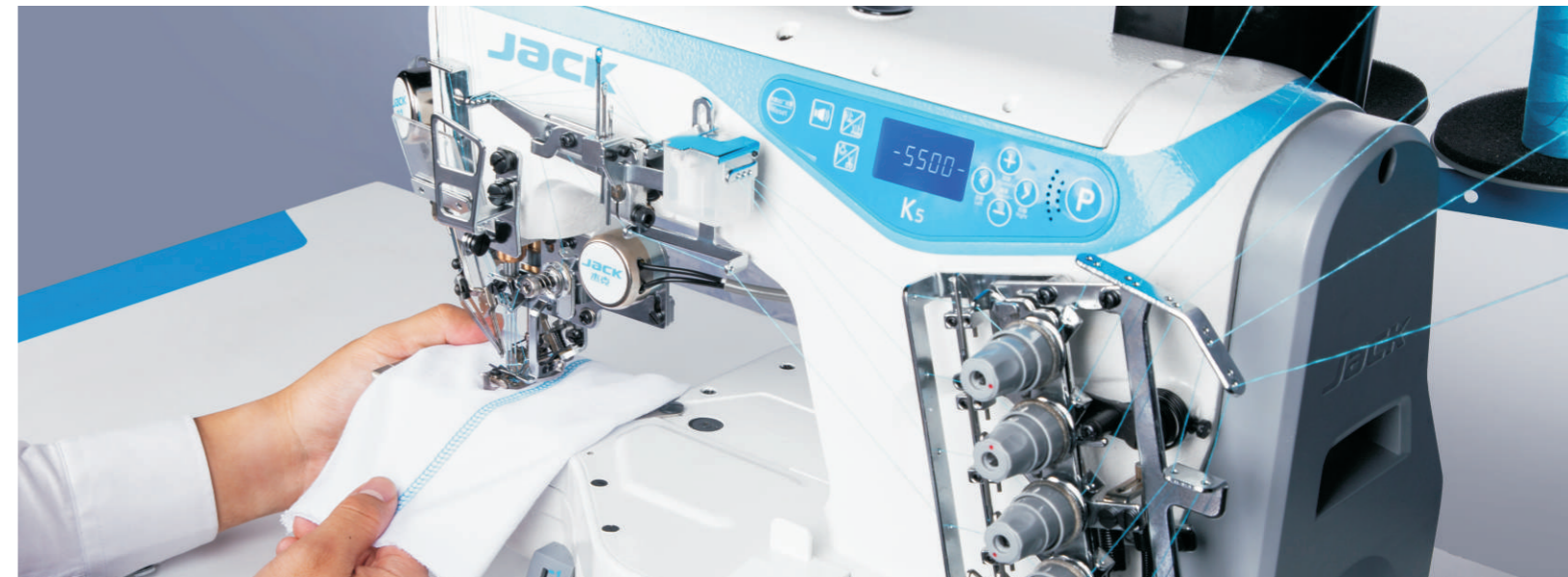

## Super High Speed Computerized Cylinder-bed Interlock Machine



K5

# K5

Item: Super High Speed Computerized Cylinder-bed Interlock Machine  
 Features: High Speed, Stable, High yield

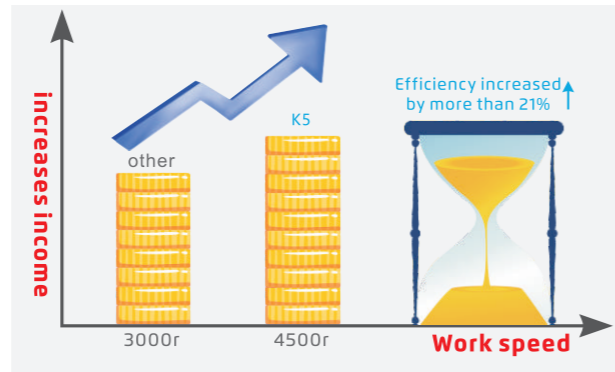

## 1 High speed, high yield

K5's normal working speed is 4500 rpm, compared with 3700rpm of normal interlock machine, the efficiency is increased by more than 21%. if one worker's monthly salary is 4000RMB, it will increase to 4840RMB when using K5 ( $4000 \times (1+0.21) = 4840\text{RMB}$ ), monthly salary increment is 840RMB for workers, which means 1260RMB gain increase per month for the owner, according to the 4:6 income ratio between workers and owner.

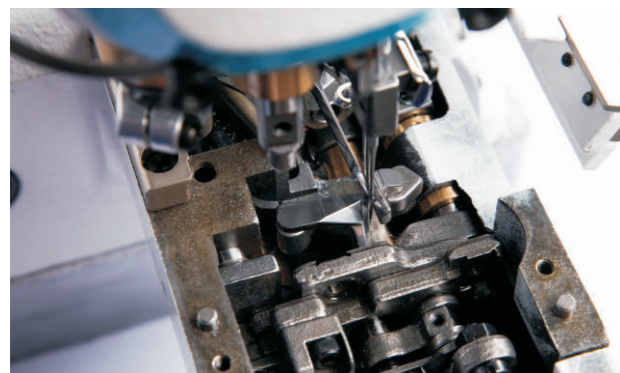

## 2 Stable thread trimming, no skipping

No skipping when start sewing, ensuring high quality sewing fabric, and the thread trimming performance is stable, greatly reducing the occurrence of occasional accident that the thread can't be cut.

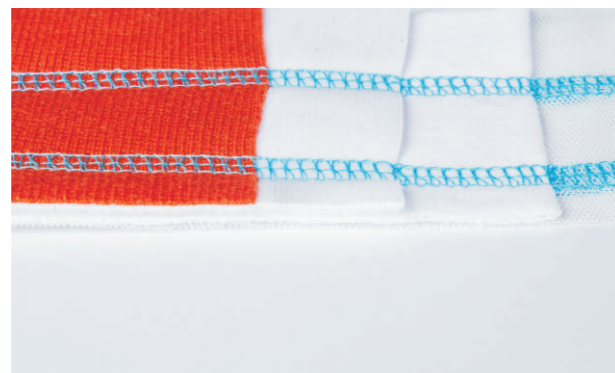

## 3 Wide adaptability of fabric

Able to sew the thin material mesh and 8 layers ordinary knitting thickness fabric without any adjustment, and beautiful stitch.



## 4 One key to reset, easy to operate

Users can restore to their own parameters or factory parameters according to the needs, more user-friendly and no need to worry if misuse.

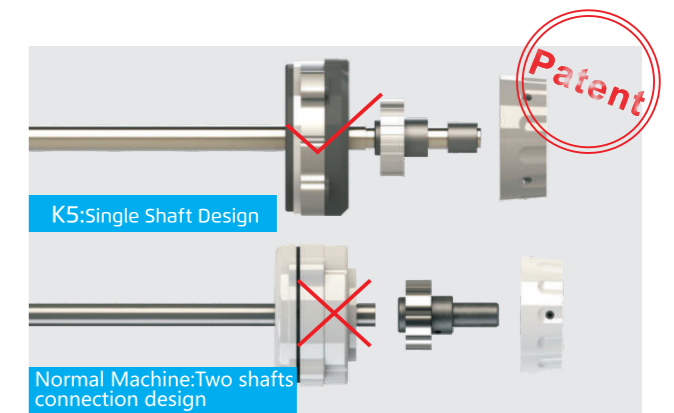

## 5 One main shaft, stable and fast

Reduce the machine torque, making the sewing fast, stable and durable.

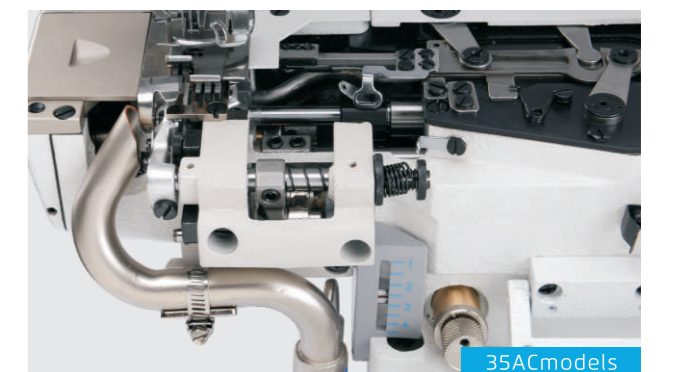
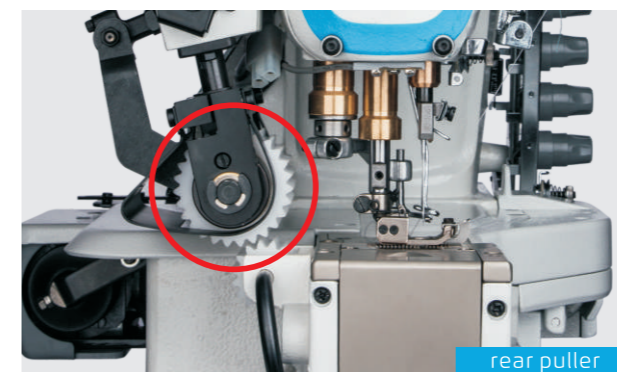
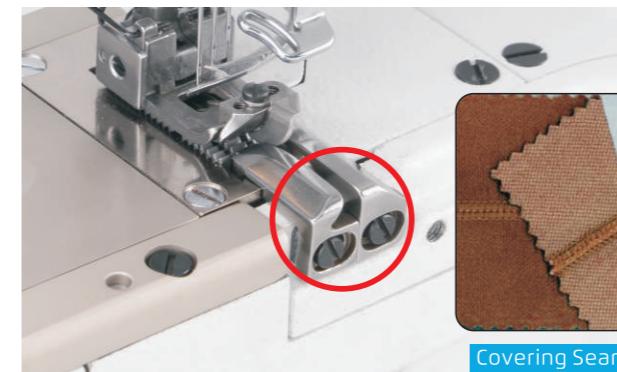

## 6 K5 optional add-on and model